

TKP-90 PLATE COMPACTOR (CLUTCH) EXPLODED DRAWING

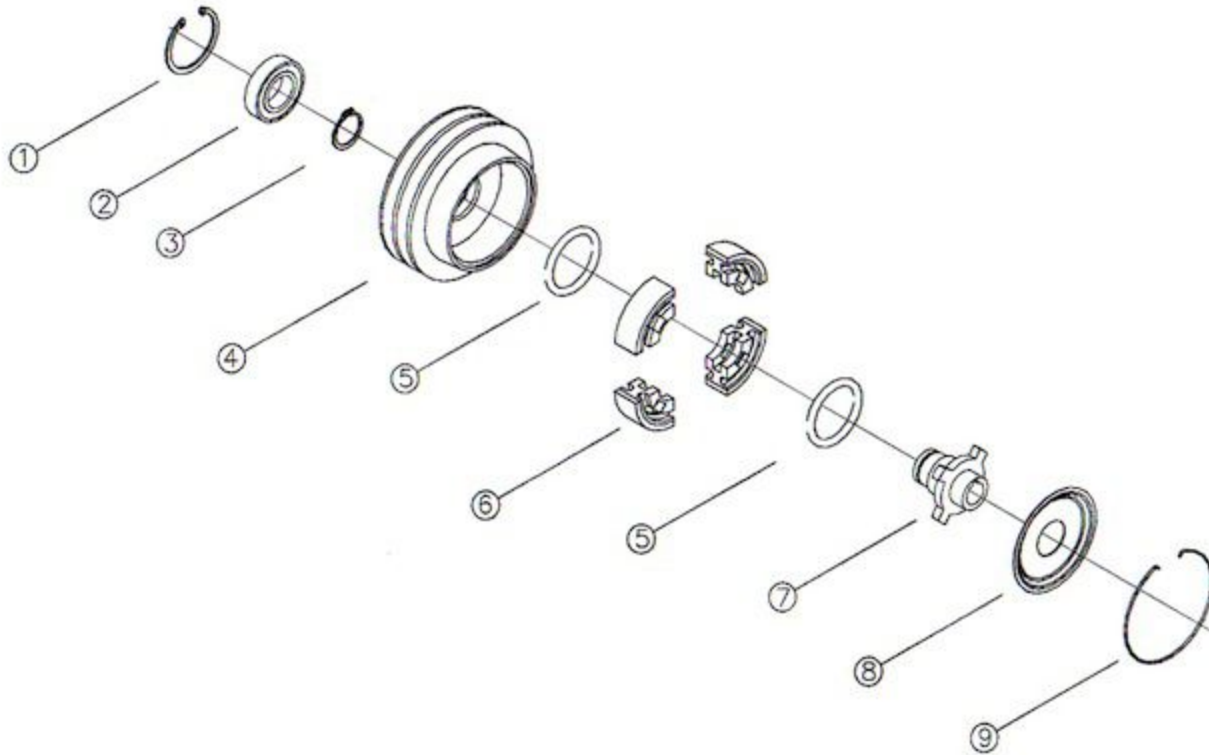

9	CLUTCH COVER CLIP	1
8	CLUTCH COVER	1
7	CLUTCH SHOE HOLDER	1
6	CLUTCH SHOE	1
5	SPRING	2
4	CLUTCH PULLEY	1
3	CIRCLIP A30	1
2	BEARING 6006 - 2RS	1
1	CIRCLIP B55	1
NO.	DESCRIPTION	QTY