

POWER TROWEL (TKT-40A) EXPLODED DRAWING

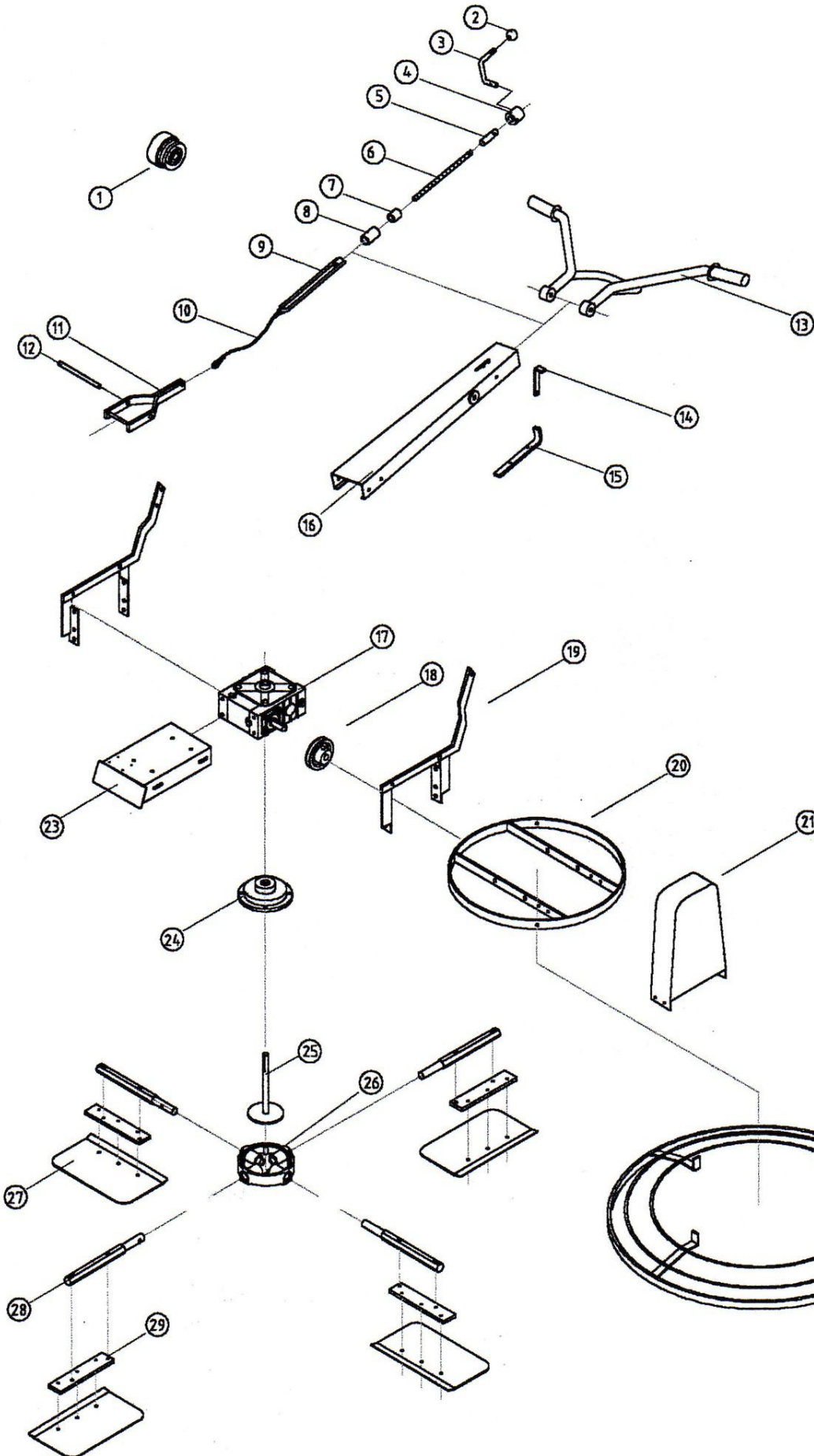

REF.NO	DESCRIPTION
1	CLUTCH PULLEY
2	BLADE ADJ.KNOB
3	BLADE ADJ.ROD
4	BLADE ADJ.BUSH
5	SCREW ROD BUSH
6	SCREW ROD
7	BRASS BUSH
8	BUSH
9	WIRE ROPE RETAINER
10	WIRE ROPE
11	LEVER ARM
12	LEVER ARM PIVOT
13	HANDLE
14	AUTO CUT OFF LEVER
15	TILT TRANS. GUIDE
16	HANDLE BAR STEM
17	GEAR BOX
18	GEAR BOX PULLEY
19	GEAR BOX BRACKET
20	GUARD RING (INNER)
21	BELT COVER
22	GUARD RING (OUTER)
23	ENG.MOUNTING
24	DRIVE PLATE
25	TILT PUSH FLANGE ROD
26	BLADE HOLDER BASE
27	BLADE
28	HEX.BLADE ARM
29	BLADE SUPPORT